

modum



catalogo 2024

modum

^{IT} Modum si rinnova con una prima collezione che nasce da un nuovo approccio al design. La sua rinnovata identità nasce dall'osservazione delle relazioni tra lo spazio e l'individuo, in cui emergono nuove esigenze che si manifestano in diversi modi di vivere. Questo porta a oggetti immersivi ed empatici, forme e soluzioni in cui riconoscersi.

^{EN} Modum is presented, after a transformation, through a first collection that comes from a new approach to design. The brand's renewed identity originates from the observation of the relationships between space and individual. Emerging new needs are translated into different ways of living, giving life to new objects, shapes and solutions that are immersive and empathic, and in which people can identify.

**Modum interpreta il modo di vivere gli spazi,
creando relazioni tra le persone e i contesti**



**EN Modum interprets real ways of
living spaces, creating relationships
between people and contexts**



^{IT} L'oggetto è progettato per essere adattabile e arricchito attraverso le interazioni con l'ambiente circostante e gli utenti. Modum osserva i significati degli spazi abitativi, rispondendo alle nuove esigenze e interpretandole a modo suo. Questo permette di creare forme, gesti e situazioni uniche.

^{EN} The object is designed to be adaptable and is enriched through interactions with the surrounding environment and the users. Modum observes the meanings of living spaces, responding to new needs and interpreting them in his own way. This allows to create unique shapes, gestures, and situations.



Indice

^{EN} Index

Balcony collection	9
Revival collection	29
Technical information	83

Balcony collection

La Collezione
Balcony
dà nuovo valore
allo spazio in cui
la casa si apre sul
paesaggio



EN The *Balcony* collection gives new value to the space, where the house opens to the landscape



IT Balcony trasforma piccoli spazi in luoghi da vivere in modo spontaneo e intimo, in cui ogni scenografia è unica e profondamente personale. Forme, contesti e paesaggi concorrono a creare atmosfere preziose e inaspettate.

EN Balcony turns small spaces into intimate and spontaneous places in which each scenography is unique and profoundly individual. Shapes, contexts, and landscapes combine to create precious and unexpected atmospheres.

IT Colori presenti nell'immagine
EN Colors represented in the picture

- | | |
|---|---|
| <p>56 IT Portavaso Balcony
 EN Balcony vase holder</p> <p>IT Pouf Balcony
 EN Balcony pouf</p> <p>50 IT Panca Balcony
 EN Balcony bench</p> <p>IT Tavolino Balcony
 EN Balcony coffee table</p> <p>● IT Piano tavolino Balcony
 EN Balcony coffee table top</p> <p>(NE) IT Lampada Balcony
 EN Balcony lamp</p> | <p>56 IT Pouf Balcony
 EN Balcony pouf</p> <p>50 IT Pouf Balcony
 EN Balcony pouf</p> <p>IT Tavolino Balcony
 EN Balcony coffee table</p> <p>● IT Piano tavolino Balcony
 EN Balcony coffee table top</p> <p>(NE) IT Lampada Balcony
 EN Balcony lamp</p> |
|---|---|

Panca *Balcony*

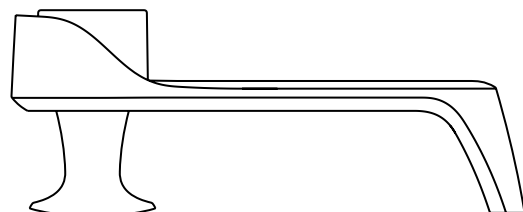

EN **Balcony bench**

IT La panca Balcony è il pezzo centrale della collezione. È l'aggiunta perfetta a qualsiasi casa. La progettazione parte da un elemento della natura, che la rende non solo bella ma anche funzionale.

Nasce come risposta ad un'esigenza condivisa e diventa simbolo di connessione e scambio, tra interno ed esterno, spazio personale e pubblico. Un posto comodo per sedersi e rilassarsi, godendo dell'ambiente circostante.

EN The Balcony bench is the central piece of the collection. It is the perfect supplement to any house. Its design takes inspiration from an element of nature, which makes it not only beautiful but also functional. It is conceived as a response to a shared need and becomes a symbol of connection and exchange between inside and outside, personal and public space. A comfortable place to sit and relax, enjoying the surroundings.



IT Colori presenti nell'immagine
EN Colors represented in the picture

56 **IT** Portavaso Balcony
EN Balcony vase holder

W **IT** Panca Balcony
EN Balcony bench

50 **IT** Panca Balcony
EN Balcony bench

66 **IT** Portavaso Balcony
EN Balcony vase holder

Panca *Balcony*

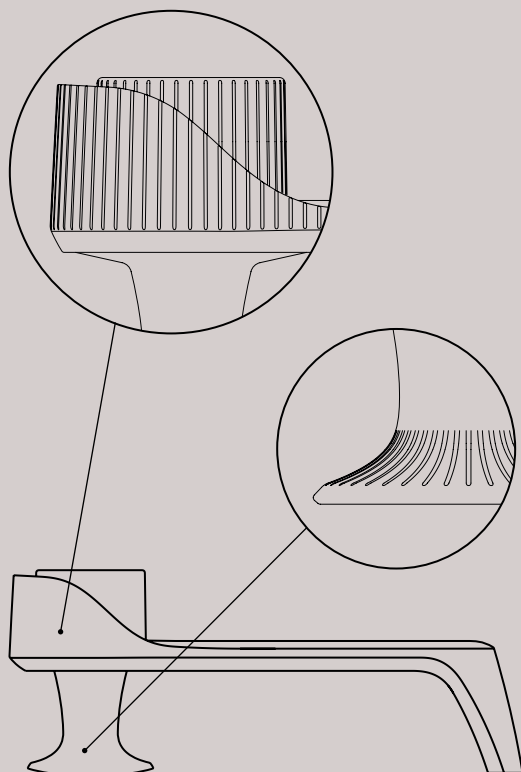

^{EN} **Balcony bench**

^{IT} **Dimensioni** ^{EN} **Dimensions**

Altezza / Height 66 cm
Lunghezza / Length 163 cm
Larghezza / Width 52 cm

^{IT} **Caratteristiche** ^{EN} **Features**

^{IT} Texture decorativa a righe lungo il profilo della panca e del portavaso.

^{EN} Decorative striped texture along the profile of the bench and the vase holder.

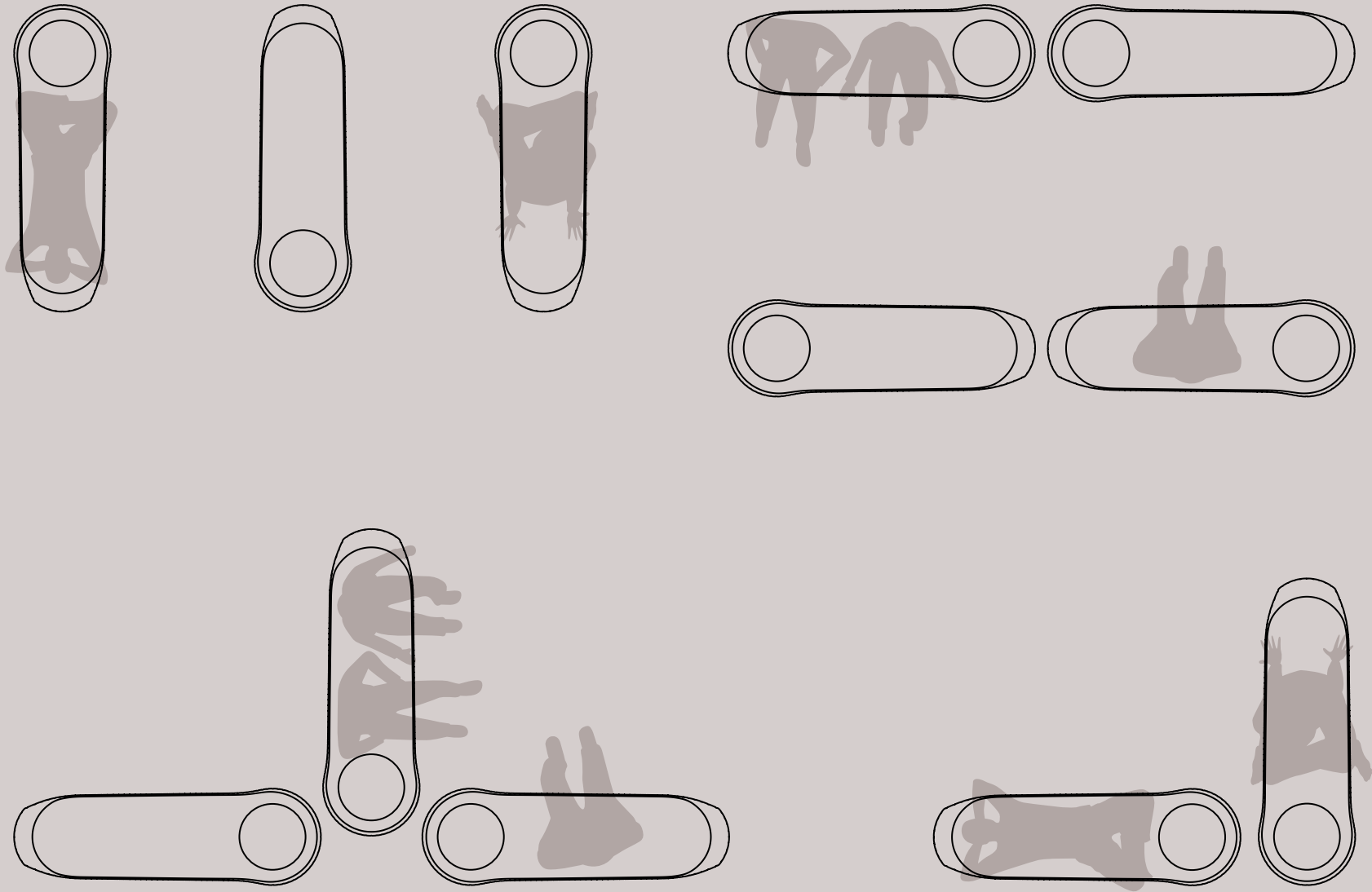

Lampada *Balcony*

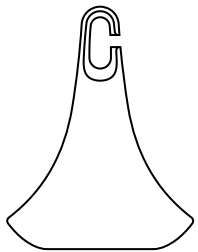

EN **Balcony lamp**





IT La lampada, in equilibrio tra eleganza e semplicità, permette di scegliere la temperatura della luce per definire l'atmosfera dell'ambiente. Appesa o appoggiata a una superficie, dona un tocco di raffinatezza a qualsiasi spazio. Grazie alle sue diverse tonalità e intensità, può adattarsi facilmente allo stato d'animo e all'occasione.

EN The lamp, in perfect balance between elegance and simplicity, allows to choose the light temperature to define the atmosphere of the environment. Hanging or standing on a surface, it adds a touch of sophistication to any space. Thanks to its different shades and intensities, it can easily adapt to the mood and the occasion.

IT Colori presenti nell'immagine
EN Colors represented in the picture

NE **IT** Lampada Balcony
EN Balcony lamp

Lampada *Balcony*

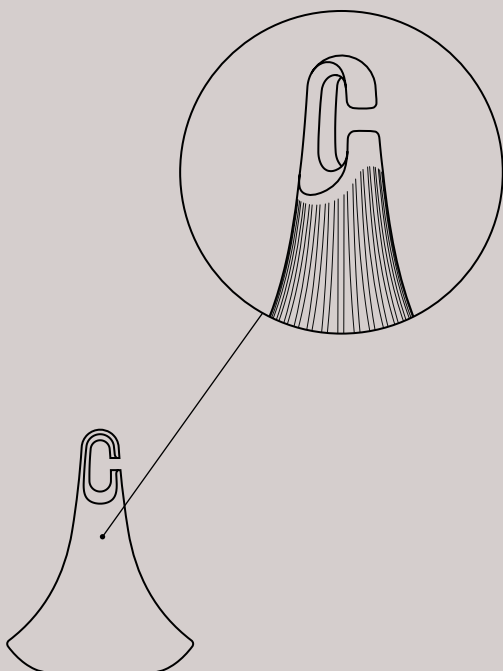

^{EN} **Balcony lamp**

^{IT} **Dimensioni** ^{EN} **Dimensions**

Altezza / Height 40 cm
Larghezza / Width 31 cm

^{IT} **Caratteristiche** ^{EN} **Features**

^{IT} La lampada presenta una texture decorativa a righe e un gancio all'estremità per poterla appendere

^{EN} The lamp has a decorative striped texture and a hook at the edge allowing to hang it.

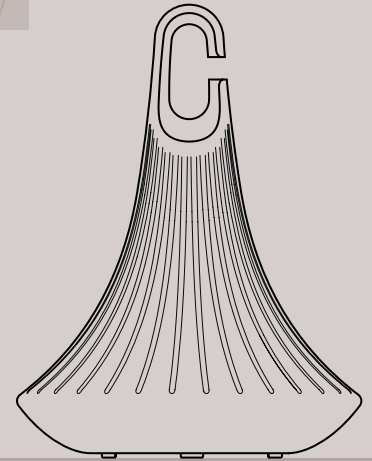
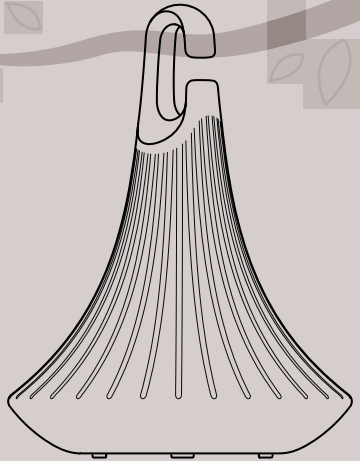

Tavolino *Balcony*

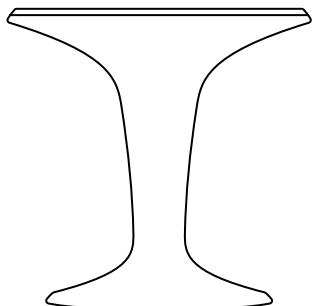

EN **Balcony** coffee table



IT La bicromia della panca viene ripresa nel tavolino, così come le forme morbide e le scanalature ritmiche che caratterizzano l'intera collezione. Il piano in legno naturale interpreta in chiave materica il legame con la natura. Che venga utilizzato come tavolino da caffè o come complemento d'arredo, questo tavolino non mancherà di stupire.

EN The duotone of the bench is also found in the coffee table, as well as the soft shapes and rhythmic grooves that characterize the entire collection. The natural wood top represents the bond with nature and its material feel. Whether used as a coffee table or as a furniture accessory, this side table will not fail to impress.

IT Colori presenti nell'immagine
EN Colors represented in the picture

50 **IT** Tavolino Balcony
EN Balcony coffee table

IT Piano tavolino Balcony
EN Balcony coffee table top

Tavolino *Balcony*

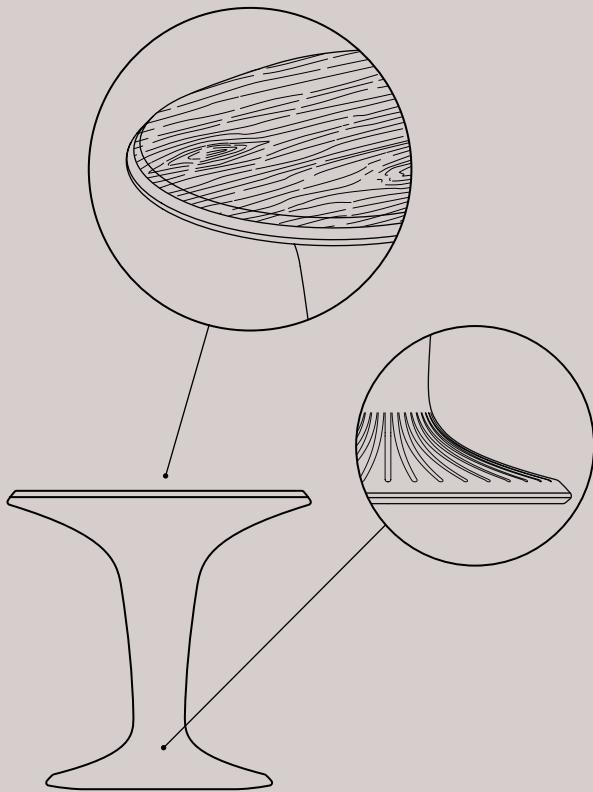

^{EN} **Balcony coffee table**

^{IT} **Dimensioni** ^{EN} **Dimensions**

Altezza / Height 53 cm
Lunghezza / Length 43 cm
Larghezza / Width 53 cm

^{IT} **Caratteristiche** ^{EN} **Features**

^{IT} Il tavolo presenta una texture decorativa a righe e il piano superiore è in legno verniciato

^{EN} The table has a decorative striped texture and a varnished wood top.



Legno okumè - colore noce
Plywood wood - walnut color



Legno okumè - verniciato "cool grey"
Plywood wood - varnished "cool grey"



Legno okumè - verniciato "antracite"
Plywood wood - varnished "anthracite"

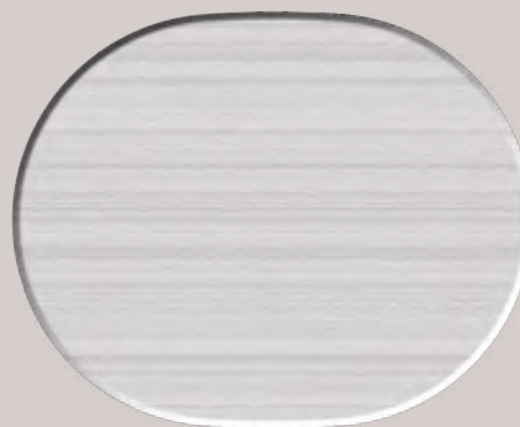

Legno okumè - verniciato "bianco"
Plywood wood - varnished "white"

Pouf *Balcony*

IT **Dimensioni**
EN **Dimensions**

Altezza / Height 43 cm
Lunghezza / Length 50 cm
Larghezza / Width 57 cm

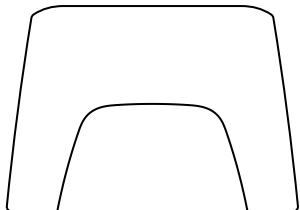

EN **Balcony pouf**





IT Il pouf da balcone è il tocco finale perfetto per questa collezione versatile, che consente libertà di espressione nella creazione di diverse combinazioni. L'ambiente creato dalla collezione Balcony può essere personalizzato in modo unico e interpretato come spazio da condividere o da tenere per sé.

EN The balcony pouf is the perfect final touch to this versatile collection, allowing freedom of expression in creating different combinations. The environment created by the Balcony collection can be customized in a unique way and interpreted as a space to be shared or enjoyed individually.

IT Caratteristiche
EN Features

IT Texture decorativa a righe lungo il profilo del pouf

EN Decorative striped texture along the profile of the pouf

IT Colori presenti nell'immagine
EN Colors represented in the picture

56 **IT** Pouf Balcony
EN Balcony pouf

77 **IT** Pouf Balcony
EN Balcony pouf



Personalizzazione collezione *Balcony*

^{IT} Le combinazioni di colore della collezione *Balcony* sono totalmente personalizzabili grazie ad una vasta gamma di colori offerti (vedi pg. 92)

^{EN} The color combinations of the *Balcony* collection are totally customizable thanks to a wide range of colors (see pg. 92)

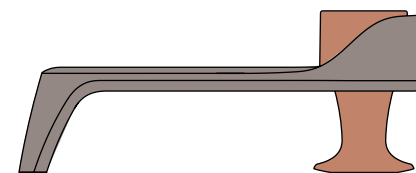
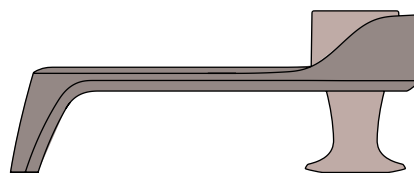
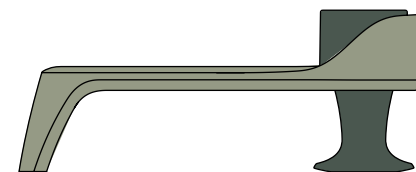
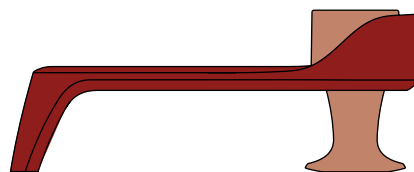
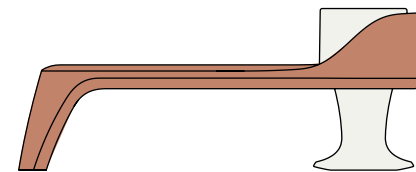
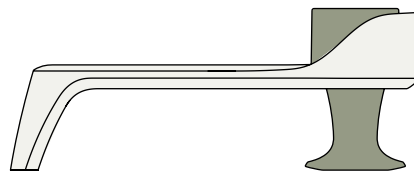

^{EN} Customized *Balcony* collection

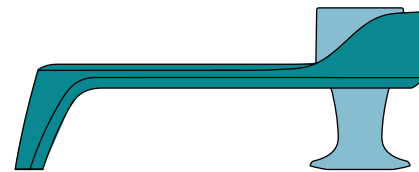
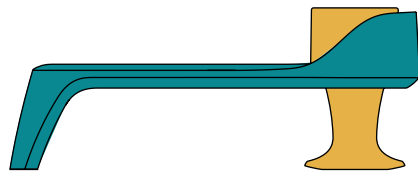
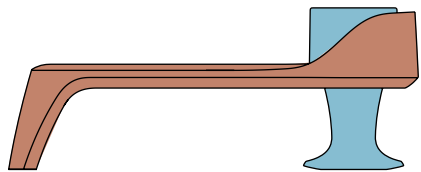
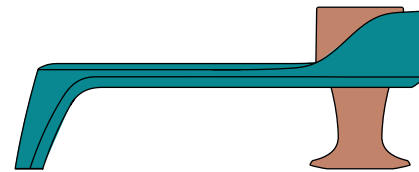
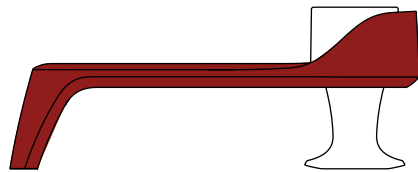
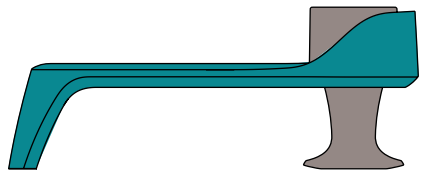
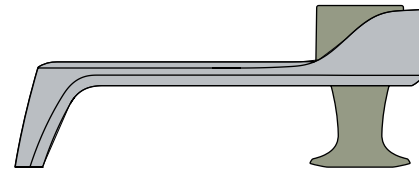
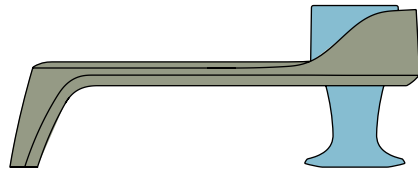
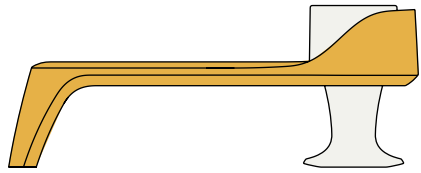

Revival collection

La Collezione
Revival:
prodotti storici,
in chiave moderna



^{EN} *Revival* collection: historical
products under a modern light



IT La Collezione Revival è un mix perfetto di stili moderni e vintage: ce n'è per tutti i gusti. Dai divani alle poltrone componibili, dai tavolini all'illuminazione, dai banconi bar agli sgabelli, dai pouf alle lampade segnaposto, la collezione Revival è sicuramente da tenere d'occhio. Prodotti storici, interpretati in chiave moderna, sorprenderanno con la loro unicità.

EN The Revival Collection is a perfect mix of modern and vintage styles: there is something for all tastes. From sofas to modular armchairs, from coffee tables to lighting, from bar counters to stools, from poufs to placeholder lamps, the Revival collection definitely deserves attention. Historical products, interpreted in a modern light, will surprise you with their uniqueness.

IT Colori presenti nell'immagine
EN Colors represented in the picture

- | | |
|--------------------------------------|---|
| (NE) Fico d'India / Wine / Margarita | (NE) Fico d'India / Margarita / Pemba / Zanzibar / Santiago |
| (49) (56) Salito | (49) (56) Salito |
| (IT) Gambo alto
(EN) High base | (49) Antigua / Onda |
| (97) Window | (97) Window |
| | (56) High base |

Sistema bancone bar modulare *Zanzibar e Pemba*

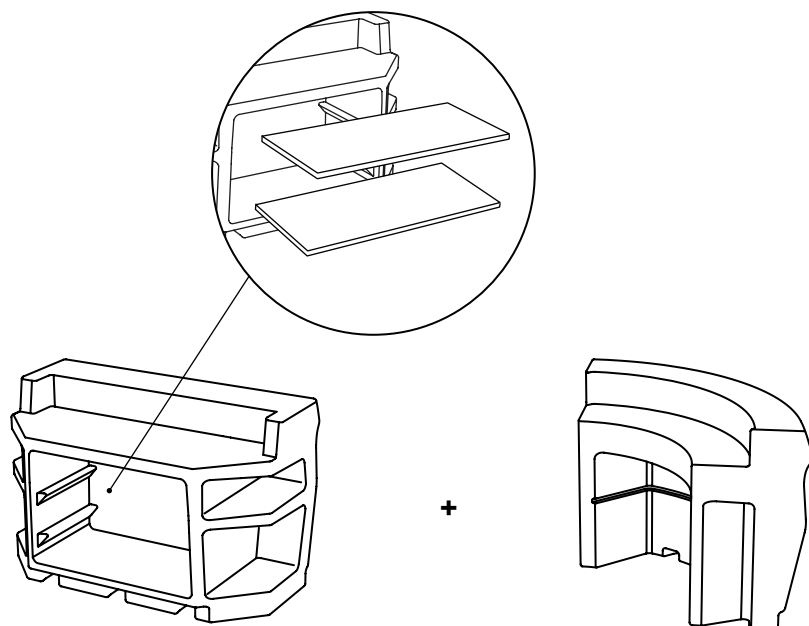

EN **Zanzibar and Pemba**
bar desk modular system

IT **Caratteristiche** EN **Features**

IT Profilo in PMMA su ripiano di lavoro nella versione standard (senza work station)

A richiesta:

ripiano in legno multistrato bianco

Max 2 pezzi per bancone

EN PMMA shelf on work base included (standard version without work station)

On request:

White plywood shelf

max 2 pieces for a bar desk

IT **Dimensioni** EN **Dimensions**

Zanzibar

Altezza / Height 110 cm

Lunghezza / Length 170 cm

Larghezza / Width 92 cm

Pemba

Altezza / Height 110 cm

Lunghezza / Length 180 cm

Larghezza / Width 80 cm

IT Colori presenti nell'immagine
EN Colors represented in the picture

BI 78 49 Pemba / Zanzibar

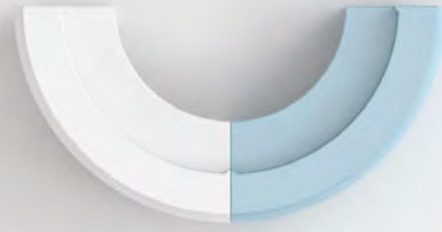

Workstation Zanzibar

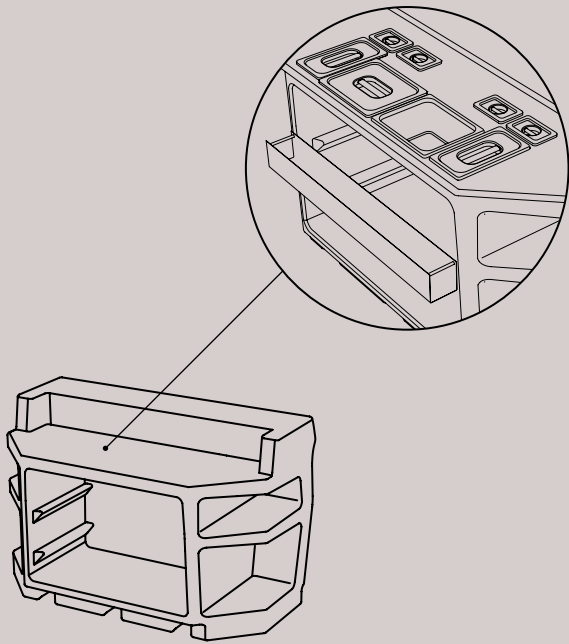

EN **Zanzibar workstation**



IT Zanzibar Workstation con accessori in acciaio inox e vaschette in PP alimentare, in particolare:

- Tasca porta bottiglie in acciaio inox
- 4 vaschette da 0,75 litri in PP alimentare
- 2 vasche da 5 litri in acciaio inox
- 2 vasche da 9 litri in acciaio inox

tutte con relativo coperchio.

EN Zanzibar Workstation with stainless steel accessories and PP food safe trays:

- Stainless steel bottle holder
- 4 trays by 0,75 liters in food safe PP
- 2 trays by 5 liters in stainless steel
- 2 trays by 9 liters in stainless steel

All trays are furnished with their covers.

IT Colori presenti nell'immagine
EN Colors represented in the picture

Sgabello *Salito*

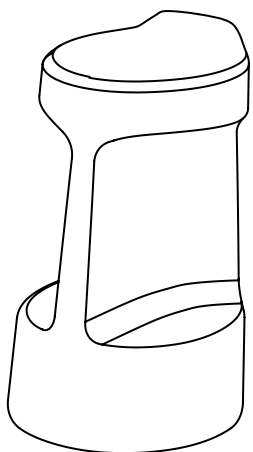

EN **Salito stool**

IT **Dimensioni**
EN **Dimensions**

Altezza/Height 75cm
Larghezza / Length Ø 40cm
Profondità/Width 47cm

IT **Colori presenti nell'immagine**
EN **Colors represented in the picture**

66 50 49 *Salito*

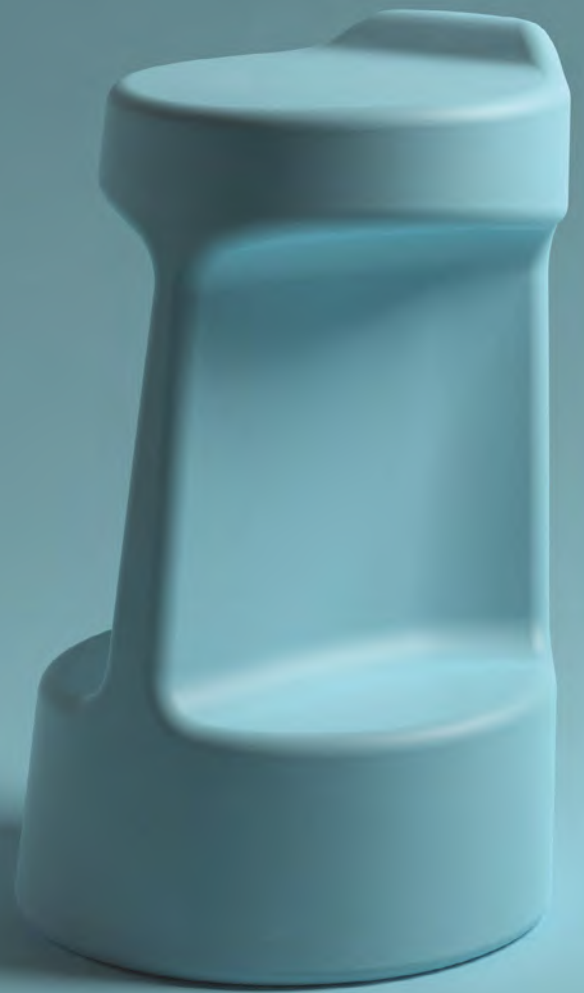

Tavolino alto calice *Margarita e Wine*

IT **Caratteristiche**
EN **Features**

IT Piano superiore in PMMA

EN Table top in PMMA

IT **Dimensioni**
EN **Dimensions**

Altezza / Height 114 cm

Lunghezza / Length 60 cm

Larghezza / Width 60 cm

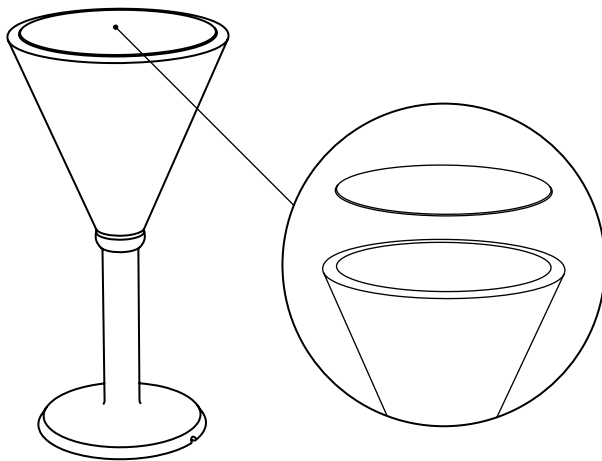

EN **Margarita and Wine bistro goblet table**



IT Caratteristiche

EN Features

IT Piano superiore in PMMA

EN Table top in PMMA

IT Dimensioni

EN Dimensions

Altezza / Height 114 cm

Lunghezza / Length 60 cm

Larghezza / Width 60 cm

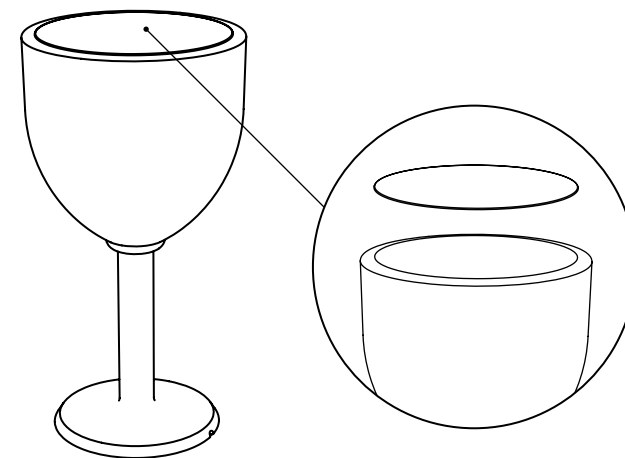

IT Colori presenti nell'immagine

EN Colors represented in the picture

(NE) Margarita / Wine

(66) **(48)** **IT** Gambo alto
EN High base

Scaffale *Window*

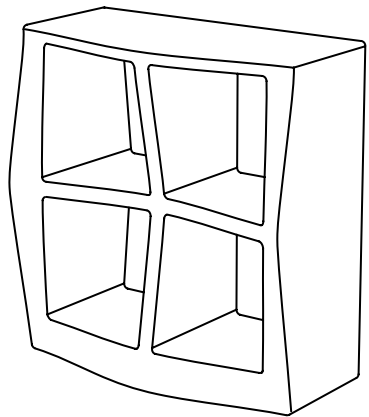

EN **Window shelf**

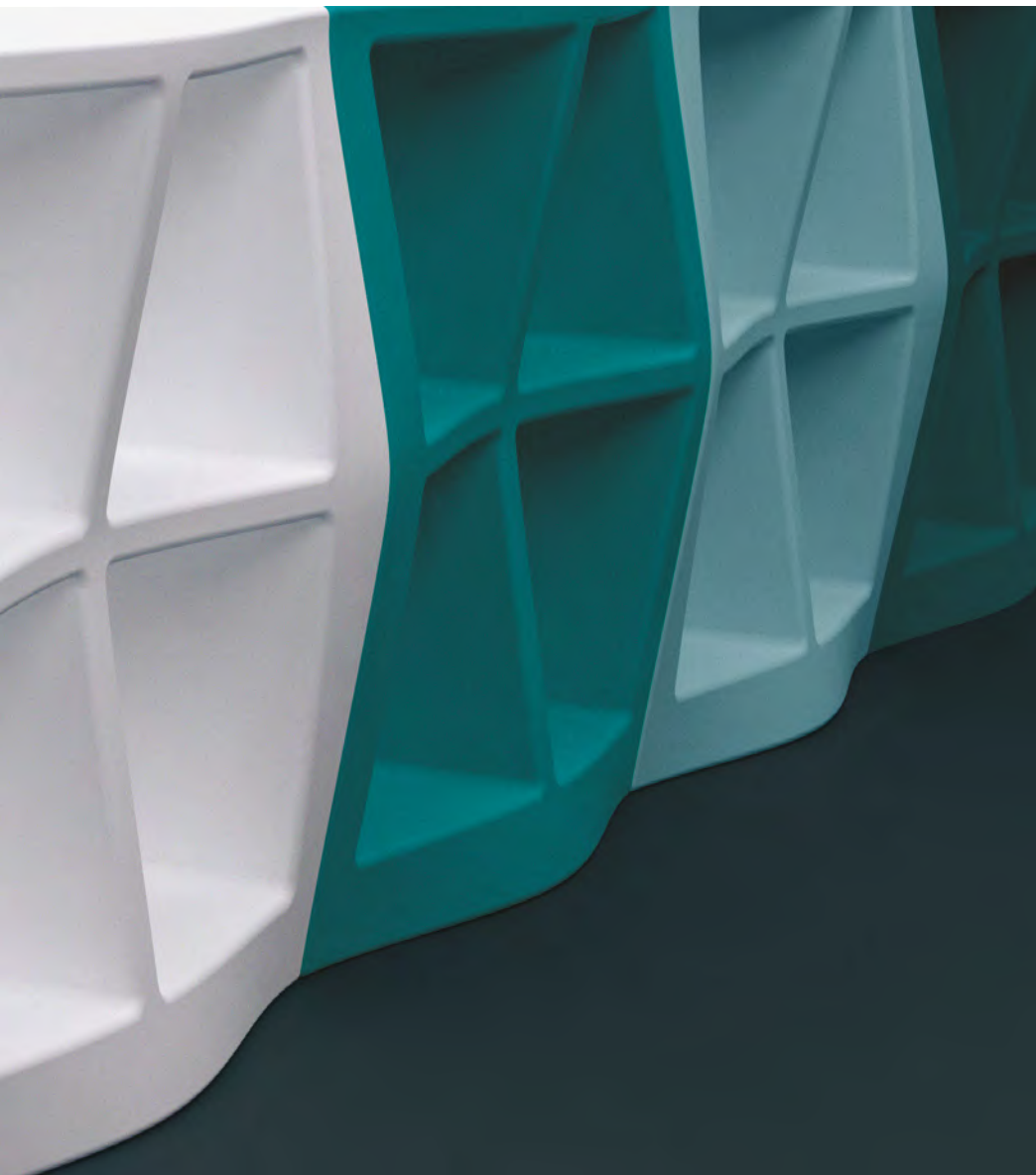

IT Dimensioni
EN Dimensions

Altezza / Height 83 cm
Lunghezza / Length 83 cm
Larghezza / Width 41 cm

IT Colori presenti nell'immagine
EN Colors represented in the picture

56 (BI) 50 49 48 Window

Portavaso
portaghiaccio
Santiago

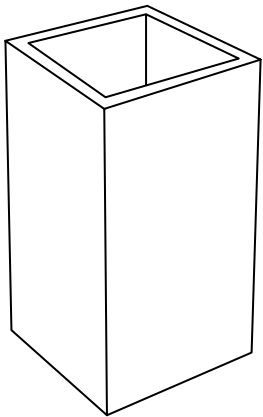

EN **Santiago** cachepot - ice bucket



IT Dimensioni
EN Dimensions

Altezza / Height 80 cm
Lunghezza / Length 40 cm
Profondità / Width 40 cm
Altezza vano interno / Inner pot height 31 cm

IT Colori presenti nell'immagine
EN Colors represented in the picture

Ⓝ NE Santiago

Ⓝ BI Manila / Tobago 40

Lampada
segnaposto
Fico d'India

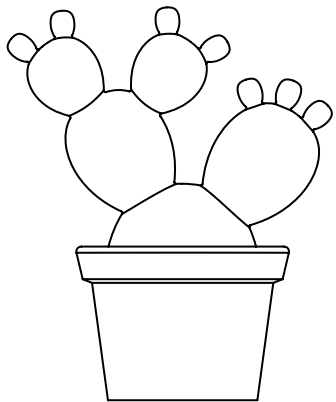

EN *Fico d'India* placeholder Lamp



IT Dimensioni
EN Dimensions

Altezza / Height 25 cm
Larghezza / Length 20 cm
Profondità / Width 15 cm

IT Colori presenti nell'immagine
EN Colors represented in the picture

56 Fico d'india

NE Fico d'india





^{IT} Colori presenti nell'immagine
^{EN} Colors represented in the picture

97 *Manila / Antigua / Tobago 40*

NE *Lighthouse / Abat-champ*

57 ^{IT} *Gambo alto*
^{EN} *High base*

Poltrona *Manila*

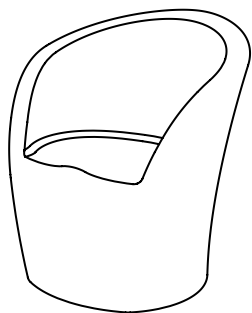

EN **Manila** armchair

IT **Dimensioni** EN **Dimensions**

Altezza / Height 80 cm
Lunghezza / Length 74 cm
Larghezza / Width 70 cm

IT **Colori presenti nell'immagine**
EN **Colors represented in the picture**



Tavolino *Tobago*

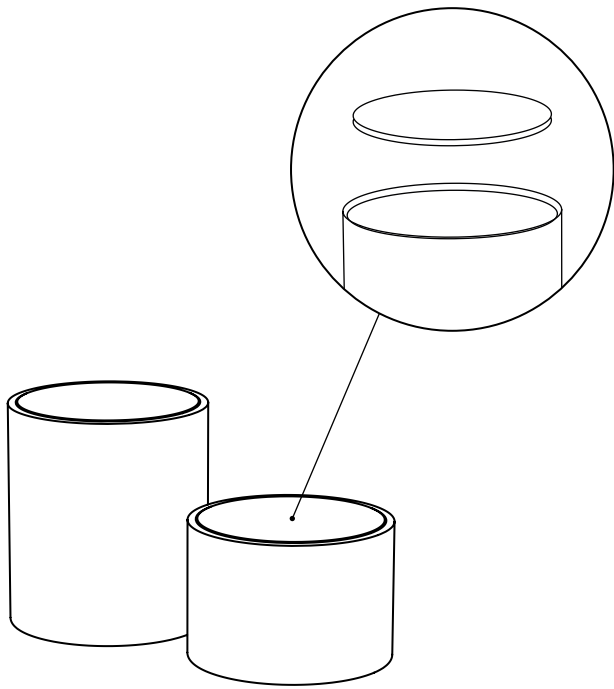

EN *Tobago* side table



IT Caratteristiche
EN Features

IT Piano superiore in PMMA

EN Table top in PMMA

IT Dimensioni
EN Dimensions

Tobago 65

Altezza / Height 65 cm

Diametro / Diameter 60 cm

Tobago 40

Altezza / Height 40 cm

Diametro / Diameter 60 cm

IT Colori presenti nell'immagine
EN Colors represented in the picture

  Tobago

 Tobago

Tavolino *Antigua*

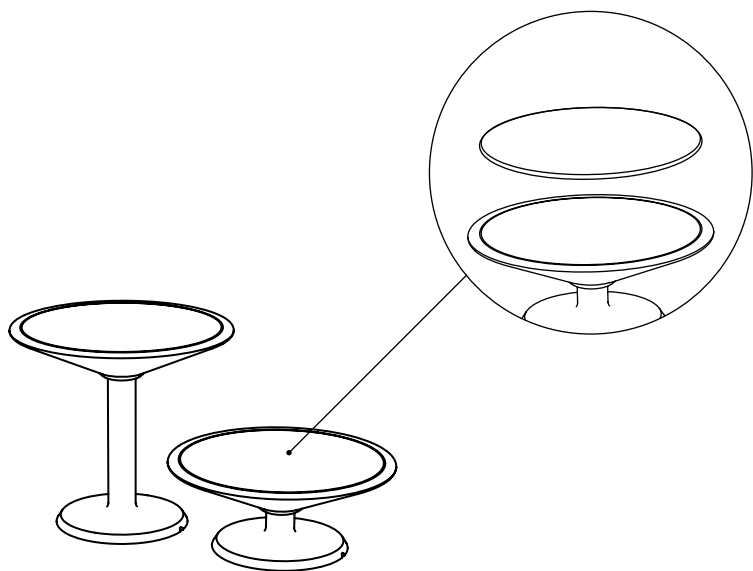

EN **Antigua coffee table**

IT **Caratteristiche** EN **Features**

IT Piano superiore in PMMA
EN Table top in PMMA

IT **Dimensioni** EN **Dimensions**

Alto: altezza / High: height 75 cm
Basso: altezza / Low: height 38
Diametro / Diameter 80 cm

IT **Colori presenti nell'immagine**
EN **Colors represented in the picture**

56 *Antigua* / IT Gambo alto EN High base / IT Gambo basso EN Low base



Lampada *Lighthouse*

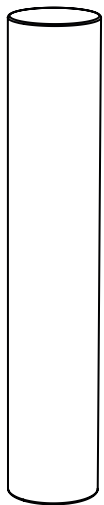

EN *Lighthouse lamp*



IT Dimensioni
EN Dimensions

Altezza / Height 177 cm
Diametro / Diameter 33 cm

IT Colori presenti nell'immagine
EN Colors represented in the picture

BI *Manila / Tobago 40*

NE *Lighthouse*

Lampada portaghiaccio *Abat-champ*

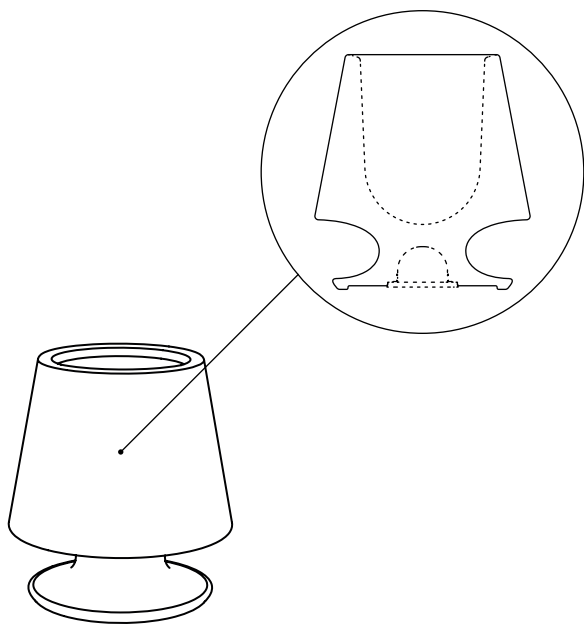

EN **Abat-champ**
lamp-icebucket

IT **Dimensioni** EN **Dimensions**

Altezza / Height 35 cm
Diametro / Diameter 30 cm
Altezza vano interno / Inner pot height 16 cm

IT **Colori presenti nell'immagine**
EN **Colors represented in the picture**

(BI) *Antigua*

(NE) *Abat-champ*







^{IT} Colori presenti nell'immagine
^{EN} Colors represented in the picture

VV *Merlino / Tobago 60*

NE *Balux / Abat-champ*

66 *Acapulco / Panama*

71 *Tobago 40*

modum — *Revival collection*

Divano
Acapulco

Poltrona
Panama

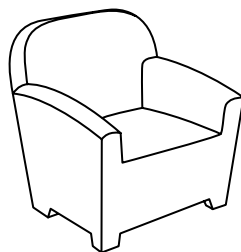
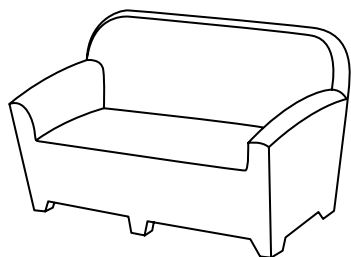

EN *Acapulco* sofa
***Panama* armchair**

IT Dimensioni
EN Dimensions

Acapulco

Altezza / Height 83 cm
Lunghezza / Length 175 cm
Larghezza / Width 67 cm

Panama

Altezza / Height 83 cm
Lunghezza / Length 78 cm
Larghezza / Width 67 cm

IT Colori presenti nell'immagine
EN Colors represented in the picture

97 *Acapulco / Panama*

NE *Balux / Tobago 40-60*







IT Colori presenti
nell'immagine
EN Colors represented
in the picture

BI 56 66

Acapulco / Panama

48 Tobago 40

49 Panama

Lampada *Balux*

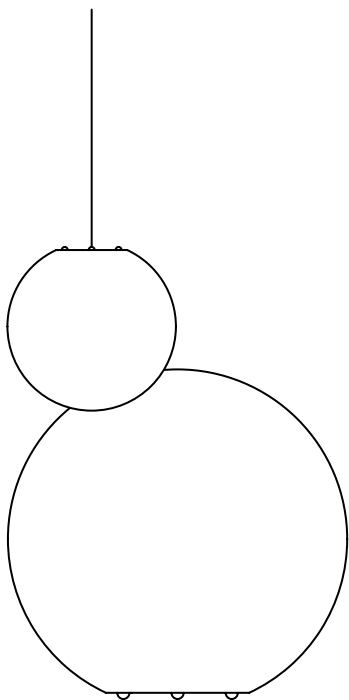

EN **Balux lamp**

IT **Dimensioni** EN **Dimensions**

Diametro / Diameter 30 cm
Altezza / Height 27 cm

Diametro / Diameter 40 cm
Altezza / Height 37 cm

Diametro / Diameter 50 cm
Altezza / Height 47 cm

Diametro / Diameter 70 cm
Altezza / Height 68 cm

Diametro / Diameter 90 cm
Altezza / Height 89 cm

IT **Colori presenti nell'immagine**
EN **Colors represented in the picture**



Lampada
appendiabiti
Merlino

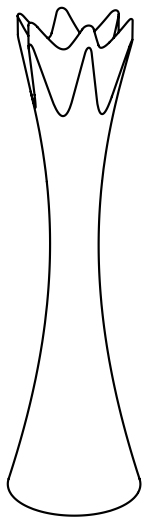

EN *Merlino* coat hanger lamp



IT Dimensioni
EN Dimensions

Altezza / Height 172 cm
Diametro / Diameter 50 cm

IT Colori presenti nell'immagine
EN Colors represented in the picture

NE 97 61 78 71 *Merlino*
97 61 66 VV 50 *Merlino*



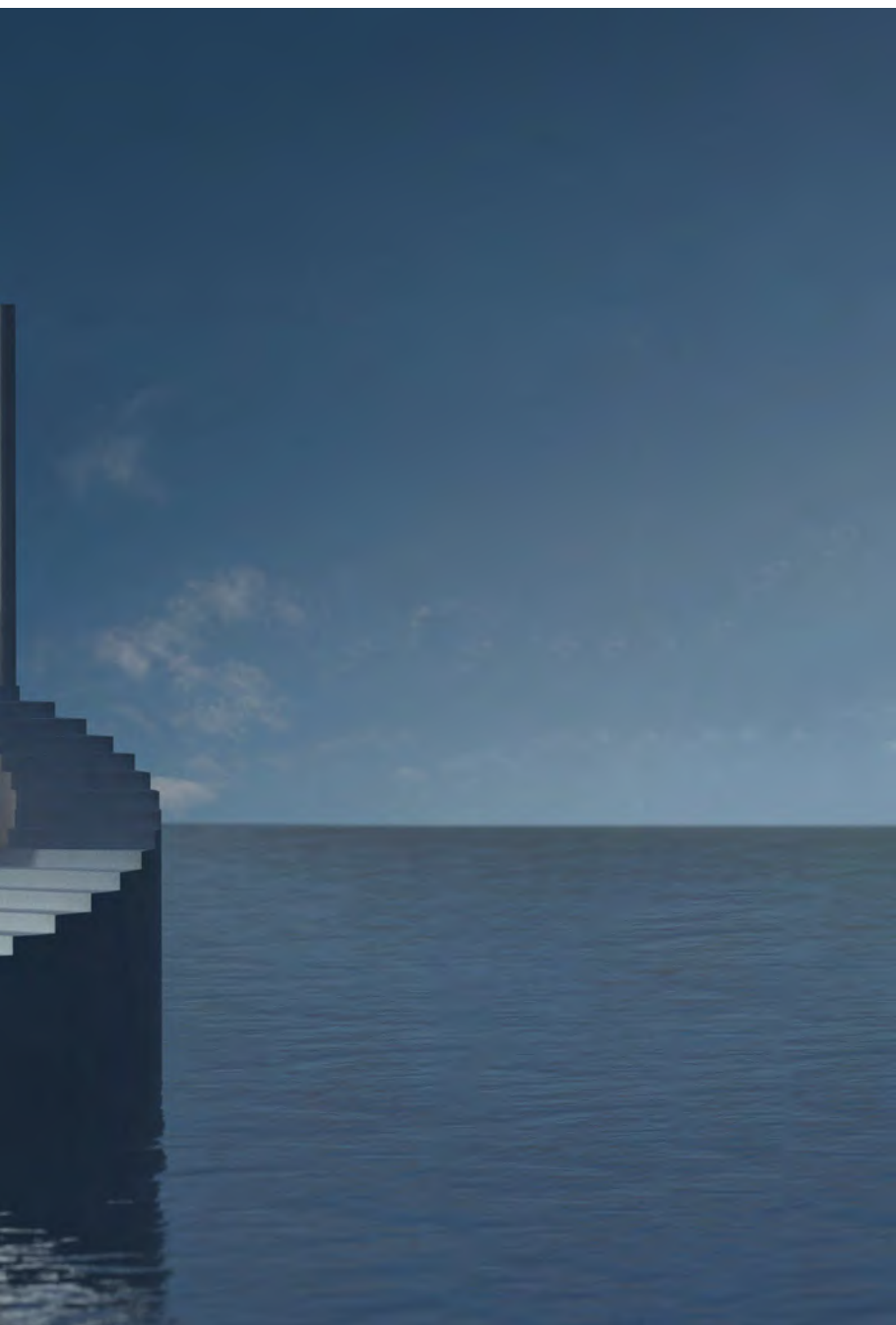

^{IT} Colori presenti nell'immagine
^{EN} Colors represented in the picture

NE Robinson / Flute / Flute base / Fico d'India

78 Margarita / Wine

77 Salito

Bancone bar *Robinson*

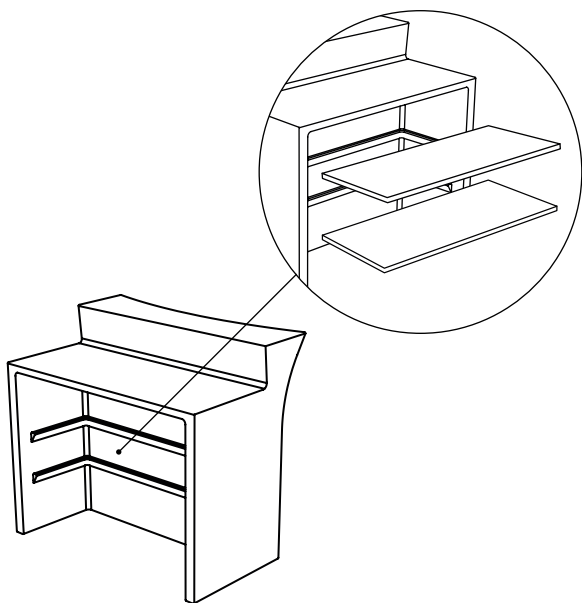

EN **Robinson bar desk**

70

IT **Caratteristiche** EN **Features**

IT Ripiani opzionali in legno multistrato
EN Plywood shelves on request

IT **Dimensioni** EN **Dimensions**

Altezza / Height 111 cm
Lunghezza / Length 120 cm
Larghezza / Width 80 cm

IT Colori presenti nell'immagine
EN Colors represented in the picture

97 *Manila / Salito*

61 *Robinson*





Lampada *Flute*

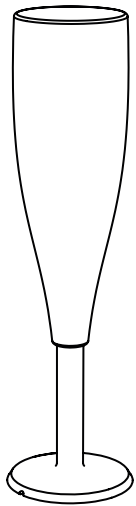

EN **Flute Lamp**

IT **Dimensioni** EN **Dimensions**

Altezza / Height 182 cm
Diametro / Diameter 43 cm

IT **Colori presenti nell'immagine**
EN **Colors represented in the picture**

(NE) *Flute / Antigua / Flute base*





^{IT} Colori presenti nell'immagine
^{EN} Colors represented in the picture

NE Balux

48 Onda / Tabasco / Antigua / ^{IT} Gambo alto ^{EN} High base

56 Onda / Tabasco / Antigua / ^{IT} Gambo basso ^{EN} Low base

Pouf *Tabasco*

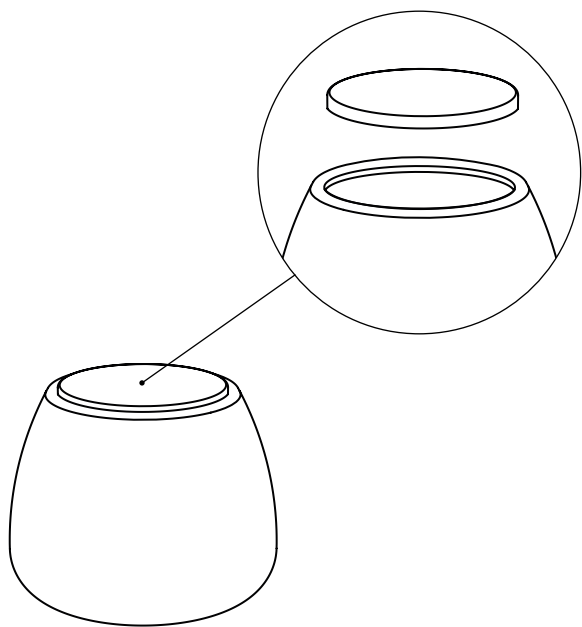

EN **Tabasco pouf**

IT **Caratteristiche** EN **Features**

IT Cuscino opzionale in tessuto idrorepellente
EN Water repellent fabric cushion on request

IT **Dimensioni** EN **Dimensions**

Altezza / Height 47 cm
Diametro / Diameter 60 cm

IT Colori presenti nell'immagine
EN Colors represented in the picture



Pouf Onda

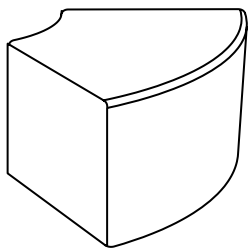

EN Onda pouf

IT Dimensioni EN Dimensions

Altezza / Height 39 cm
Lunghezza / Length 77 cm
Larghezza / Width 52 cm

IT Colori presenti nell'immagine
EN Colors represented in the picture

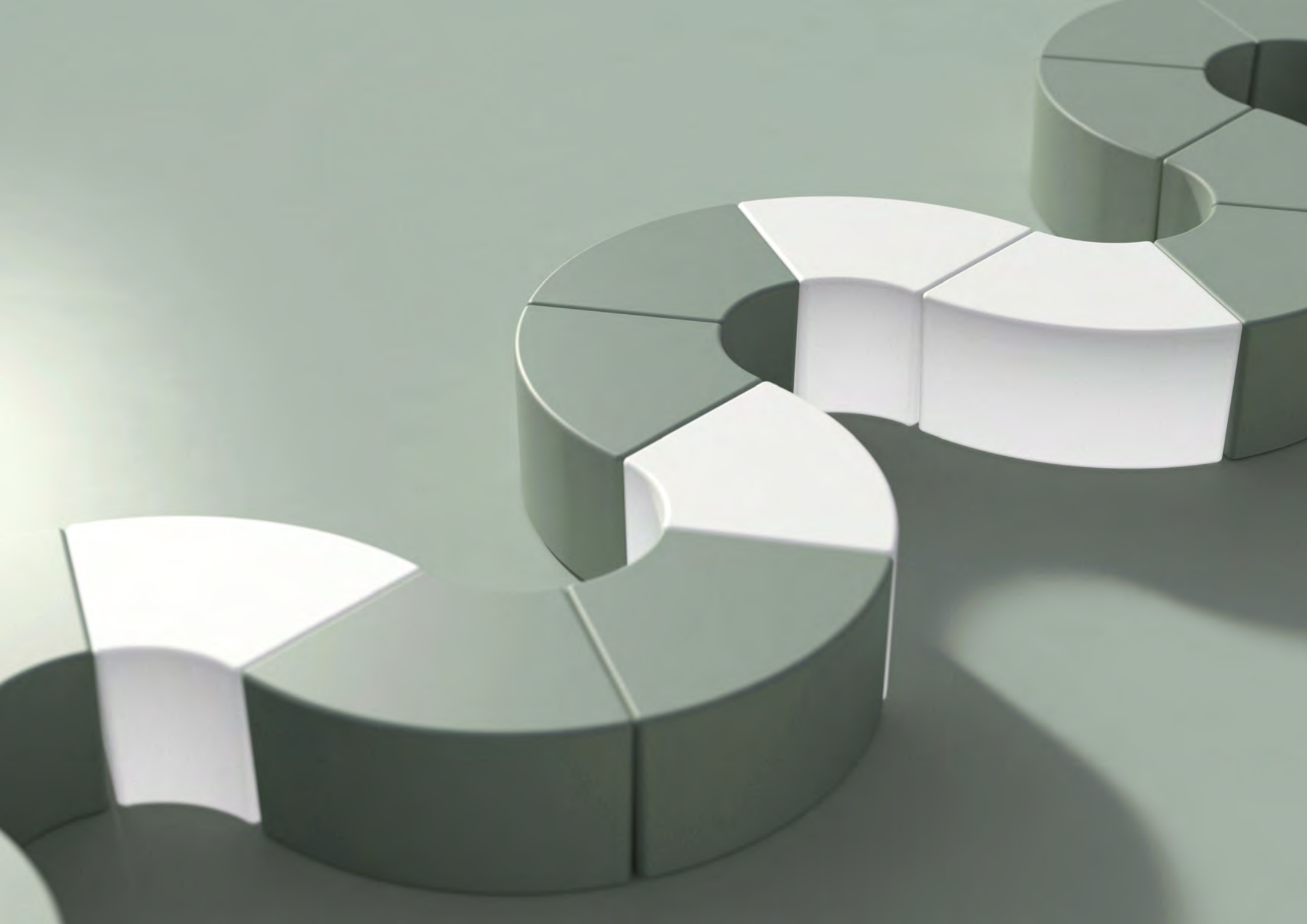

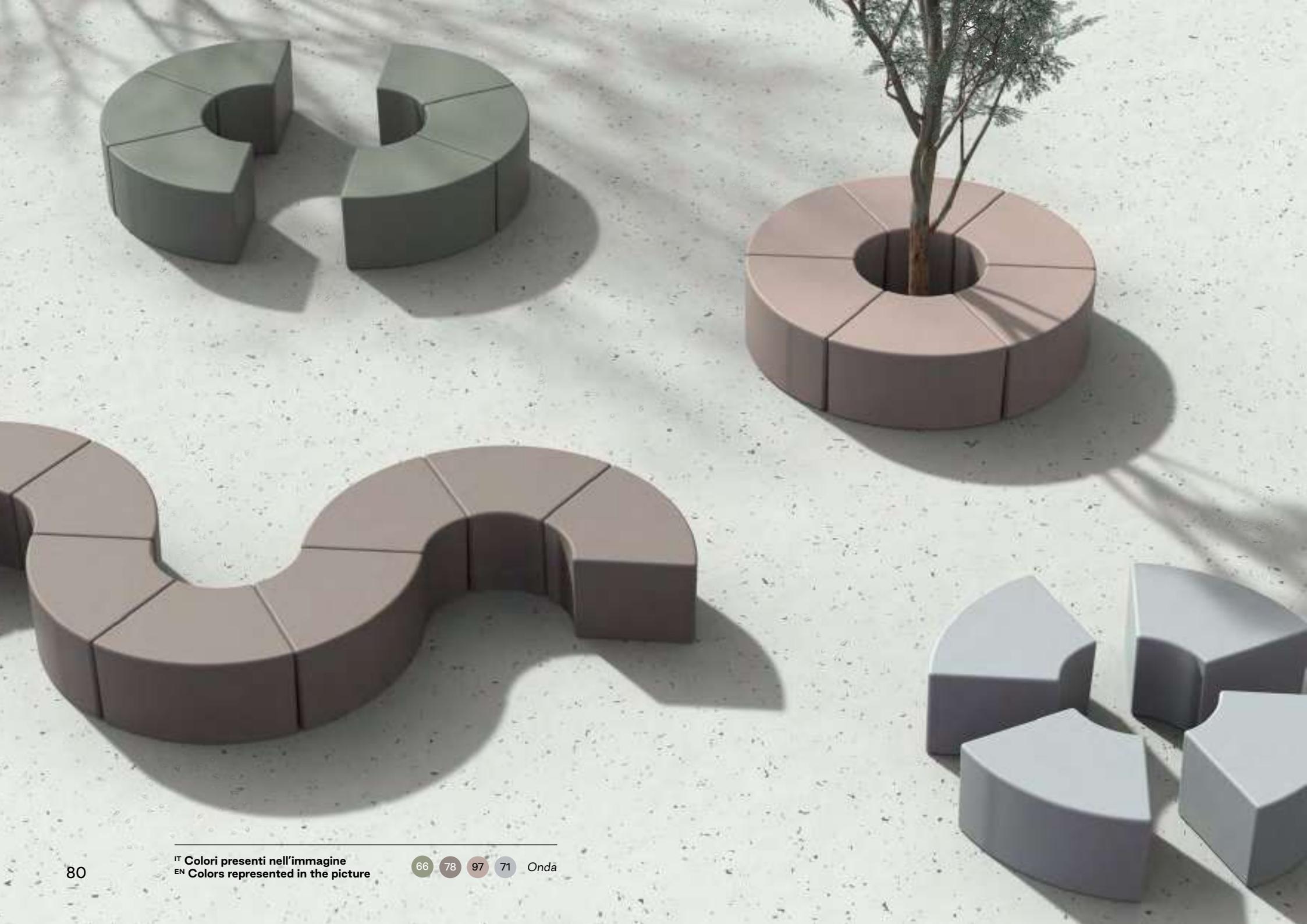

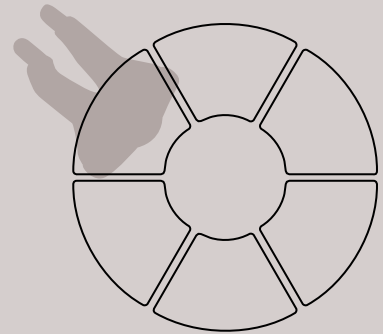
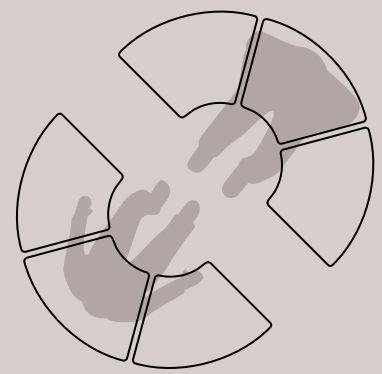
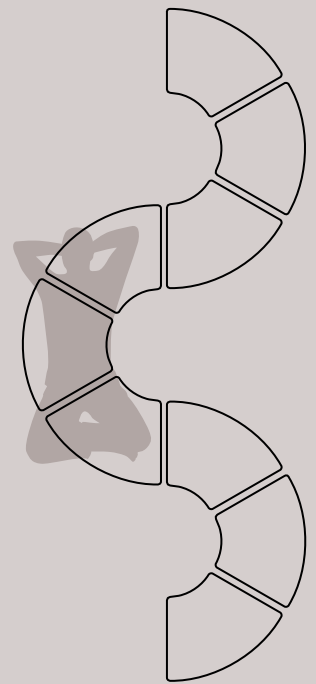
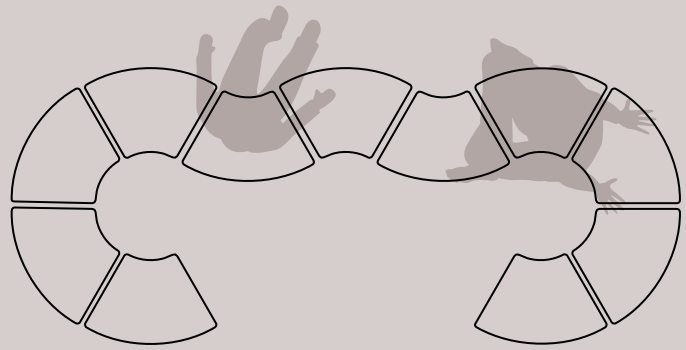
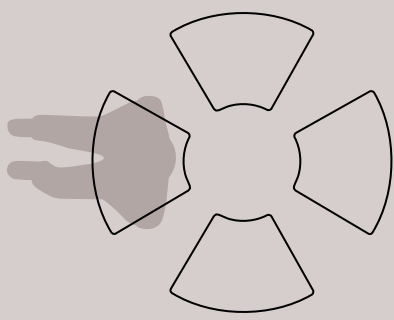
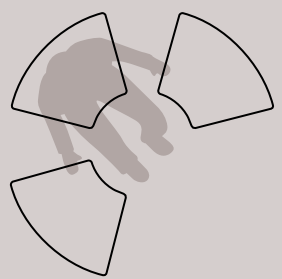











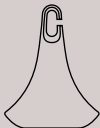
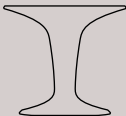
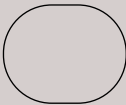
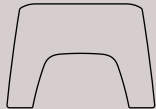

Technical information

Caratteristiche tecniche

EN Technical features



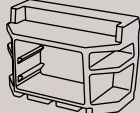
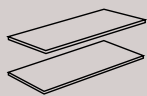
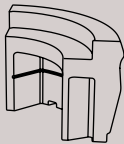

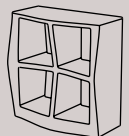
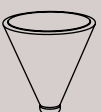



	prodotto product	dimensioni dimensions	colore color	codice code	 kit luce (cable)	 kit led (cable)	 kit rgb (cable)	 kit rgb (battery)
	p. 12 Panca Balcony Balcony bench	H. 66 cm L. 163 cm W. 52 cm	Prodotto realizzabile a richiesta in diversi colori Product available on request in different colors (pg. 92)	BALBENC 51 Prodotto da abbinare al portavaso Product to be combined with the vase holder	-	-	-	-
	p. 12 Portavaso Balcony Balcony vase holder	H. 65 cm Ø 42 cm	Prodotto realizzabile a richiesta in diversi colori Product available on request in different colors (pg. 92)	BALPOT 42 Prodotto vendibile con e senza panca Product offered with and without bench	-	-	-	-
	p. 16 Lampada Balcony Balcony lamp	H. 40 cm Ø 31 cm	Prodotto realizzabile solo in colore neutro Product available in "neutro" color only	BALLAMP 30 Kit led rgb incluso Kit led rgb included	-	-	-	✓
	p. 20 Tavolino Balcony Balcony coffee table	H. 53 cm L. 43 cm W. 53 cm	Prodotto realizzabile a richiesta in diversi colori Product available on request in different colors (pg. 92)	BALTAB 44 Prodotto da abbinare al TOP BALCONY Product to be combined with BALCONY TOP	-	-	-	-
	p. 20 Top tavolino Balcony Balcony coffee table top	H. 2 cm L. 53 cm W. 43 cm	Prodotto realizzato in legno in diversi colori Product available on request in different colors (pg. 92)	TOP BALCONY Prodotto da abbinare a BALTAB44 Product to be combined with BALTAB44	-	-	-	-
	p. 24 Pouf Balcony Balcony pouf	H. 43 cm L. 50 cm W. 57 cm	Prodotto realizzabile a richiesta in diversi colori Product available on request in different colors (pg. 92)	BALPOUF 60	-	-	-	-

Legenda / Legend

	prodotto product	dimensioni dimensions	colore color	codice code	 kit luce (cable)	 kit led (cable)	 kit rgb (cable)	 kit rgb (battery)
	p. 32 Sistema bancone bar modulare Zanzibar Bar desk modular system Zanzibar	H. 110 cm L. 170 cm W. 92 cm	Prodotto realizzabile a richiesta in diversi colori Product available on request in different colors (pg. 92)	BNC 170	-	BNC170 LED	BNC170 RGB	-
	Allestito con Workstation Equipped with Workstation			BNC 170 WS	-	BNC170 LED WS	BNC170 RGB WS	-
	p. 32 Ripiani in legno multistrato Plywood shelves	H. 2 cm L. 99 cm W. 51 cm	Prodotto realizzabile solo in colore bianco Prodotto realizzabile solo in colore bianco	RIP ZR 99 Prodotto da abbinare a Zanzibar e Pemba Product to be combined with Zanzibar and Pemba	-	-	-	-
	p. 32 Sistema bancone bar modulare Pemba Bar desk modular system Pemba	H. 110 cm L. 180 cm W. 80 cm	Prodotto realizzabile a richiesta in diversi colori Product available on request in different colors (pg. 92)	BNA 180	-	BNA180 LED	BNA180 RGB	-
	p. 36 Sgabello Salito Salito Stool	H. 75 cm L. 40 cm W. 47 cm	Prodotto realizzabile a richiesta in diversi colori Product available on request in different colors (pg. 92)	SGB 3870	-	-	-	-
	p. 40 Scaffale Window Window Shelf	H. 83 cm L. 83 cm W. 41 cm	Prodotto realizzabile a richiesta in diversi colori Product available on request in different colors (pg. 92)	LBA 40	-	-	-	-
	p. 38 Tavolino alto calice Margarita Margarita Bistro goblet table	H. 60 cm Ø 60 cm	Prodotto realizzabile a richiesta in diversi colori e venduto con piano in PMMA Product available on request in different colors and sold with PMMA top (pg. 92)	MRG 60 Prodotto da abbinare al gambo alto/basso Product to be combined with low/high base	-	-	-	-



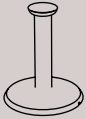

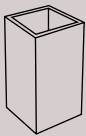



Caratteristiche tecniche

EN Technical features

	prodotto product	dimensioni dimensions	colore color	codice code	 kit luce (cable)	 kit led (cable)	 kit rgb (cable)	 kit rgb (battery)
	p. 39 Tavolino alto calice Wine Wine Bistrogoblet table	H. 60 cm Ø 60 cm	Prodotto realizzabile a richiesta in diversi colori e venduto con piano in PMMA Product available on request in different colors and sold with PMMA top (pg. 92)	VIN 60 Prodotto da abbinare al gambo alto/basso Product to be combined with low/high base	-	-	-	-
	p. 52 Tavolino Antigua Antigua Coffee table	H. 19 cm Ø 80 cm	Prodotto realizzabile a richiesta in diversi colori e venduto con piano in PMMA Product available on request in different colors and sold with PMMA top (pg. 92)	TVC 80 Prodotto da abbinare al gambo alto/basso Product to be combined with low/high base	-	-	-	-
	p. 38 52 Gambo alto High base	H. 58 cm Ø 49 cm	Prodotto realizzabile a richiesta in diversi colori Product available on request in different colors (pg. 92)	GMB 60 SK Prodotto da abbinare a Wine, Margarita e Antigua Product to be combined with Wine, Margarita and Antigua	-	GMB60	-	GMB60 RGB BT
	p. 38 52 Gambo basso Low base	H. 21 cm Ø 49 cm	Prodotto realizzabile a richiesta in diversi colori Product available on request in different colors (pg. 92)	GMB 60 B SK Prodotto da abbinare a Wine, Margarita e Antigua Product to be combined with Wine, Margarita and Antigua	-	GMB60B	-	GMB60B RGB BT
	p. 42 Portavaso portaggiaccio Santiago Santiago Cachepot Ice bucket	H. 80 cm L. 40 cm W. 40 cm HPV. 31 cm	Prodotto realizzabile a richiesta in diversi colori Product available on request in different colors (pg. 92)	QLH PV 80	✓	✓	✓	✓

Legenda / Legend

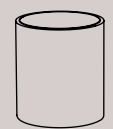
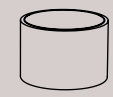
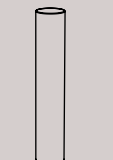







H. Altezza / Height - L. Lunghezza / Length - W. Larghezza / Width - HPV. Altezza portavaso / Vase holder internal height - PMMA Plexiglass





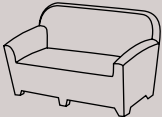

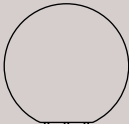

	prodotto product	dimensioni dimensions	colore color	codice code	 kit luce (cable)	 kit led (cable)	 kit rgb (cable)	 kit rgb (battery)
	p. 44 Lampada segnaposto Fico d'India Fico d'India Placeholder lamp	H. 25 cm L. 20 cm W. 15 cm	Prodotto realizzabile a richiesta in diversi colori Product available on request in different colors (pg. 92)	FDI 25	-	-	-	✓
	p. 48 Poltrona Manila Manila Armchair	H. 80 cm L. 74 cm W. 70 cm	Prodotto realizzabile a richiesta in diversi colori Product available on request in different colors (pg. 92)	POMO 74	✓	✓	✓	✓
	p. 50 Tavolino Tobago Tobago Side table	H. 65 cm Ø 60 cm	Prodotto realizzabile a richiesta in diversi colori e venduto con piano in PMMA Product available on request in different colors and sold with PMMA top (pg. 92)	CLMD 65	✓	✓	✓	✓
	p. 50 Tavolino Tobago Tobago Side table	H. 40 cm Ø 60 cm	Prodotto realizzabile a richiesta in diversi colori e venduto con piano in PMMA Product available on request in different colors and sold with PMMA top (pg. 92)	CLMD 40	✓	✓	✓	✓
	p. 54 Lampada Lighthouse Lighthouse Lamp	H. 177 cm Ø 33 cm	Prodotto realizzabile solo in colore neutro Product available in "neutro" color only	LTC 180 kit led incluso Kit led included	-	✓	-	-
	p. 56 Lampada Portagiaccio Abat-champ Abat-champ Lamp-Icebucket	H. 35 cm Ø 30 cm HPV. 16 cm	Prodotto realizzabile a richiesta in diversi colori Product available on request in different colors (pg. 92)	LMPG 33	-	-	-	✓

Per illuminazione: solo colore neutro
Lighting: neutro color only

Caratteristiche tecniche

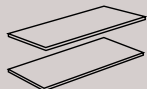
EN Technical features

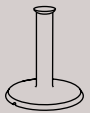
	prodotto product	dimensioni dimensions	colore color	codice code	 kit luce (cable)	 kit led (cable)	 kit rgb (cable)	 kit rgb (battery)
	p. 60 Divano Acapulco Acapulco sofa	H. 83 cm L. 175 cm W. 67 cm	Prodotto realizzabile a richiesta in diversi colori Product available on request in different colors (pg. 92)	DICOM 175	✓	✓	✓	✓
	p. 60 Poltrona Panama Panama armchair	H. 83 cm L. 78 cm W. 67 cm	Prodotto realizzabile a richiesta in diversi colori Product available on request in different colors (pg. 92)	POLCO 78	✓	✓	✓	✓
	p. 64 Lampada Balux Balux lamp	Ø 30 cm H. 27 cm	Prodotto realizzabile solo in colore neutro Product available in "neutro" color only	SFM 30	✓	✓	✓	✓
		Ø 40 cm H. 37 cm		SFM 40	✓	✓	✓	✓
		Ø 50 cm H. 47 cm		SFM 50	✓	✓	✓	✓
		Ø 70 cm H. 68 cm		SFM 70	✓	✓	✓	✓
		Ø 90 cm H. 89 cm		SFM 90	✓	✓	✓	✓
	p. 66 Lampada appendiabiti Merlino Coat hanger lamp Merlino	H. 172 cm Ø 50 cm	Prodotto realizzabile a richiesta in diversi colori Product available on request in different colors (pg. 92)	LMAB 175 SK	-	LMAB 175	-	-

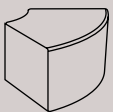
	prodotto product	dimensioni dimensions	colore color	codice code	 kit luce (cable)	 kit led (cable)	 kit rgb (cable)	 kit rgb (battery)
	p. 70 Bancone bar Robinson Robinson bar desk	H. 111 cm L. 120 cm W. 80 cm	Prodotto realizzabile a richiesta in diversi colori Product available on request in different colors (pg. 92)	BNR 120	-	BNR 120 LED	-	-
	Allestito con Workstation (piano lavoro e accessori in acciaio Inox) Equipped with Workstation (stainless steel work base and accessories)			BNR 120 WS	-	BNR 120 WS LED	-	-
	p. 70 Ripiani in legno multistrato Plywood shelves	H. 2 cm L. 102 cm W. 39 cm	Prodotto realizzabile solo in colore bianco Prodotto realizzabile solo in colore bianco	RIP BNR 120 Prodotto da abbinare a Robinson Product to be combined with Robinson	-	-	-	-
	p. 72 Lampada Flute Flute lamp	H. 108 cm Ø 43 cm	Prodotto realizzabile solo in colore neutro Product available in "neutro" color only	FLT 43	-	-	-	-
	p. 72 Gambo per lampada Flute Flute base	H. 76 cm Ø 49 cm	Prodotto realizzabile a richiesta in diversi colori Product available on request in different colors (pg. 92)	GMB 76 kit led incluso Kit led included	-	✓	-	-
	p. 76 pouf Tabasco Tabasco pouf	H. 47 cm Ø 60 cm	Prodotto realizzabile a richiesta in diversi colori Product available on request in different colors (pg. 92)	POUF 60	✓	✓	✓	✓
	p. 76 Cuscino Pillow	H. 76 cm Ø 49 cm	Sfoderabile con apertura a ZIP Removable with a zip opening	CUSCINO POUF 60 Prodotto da abbinare a Tabasco Product to be combined with Tabasco	-	-	-	-
	p. 78 Pouf Onda Onda pouf	H. 39 cm L. 77 cm W. 52 cm	Prodotto realizzabile a richiesta in diversi colori Product available on request in different colors (pg. 92)	PSK 80	✓	✓	✓	✓

Per illuminazione: solo colore neutro
Lighting: neutro color only

Indice alfabetico

^{EN} Alphabetical index

Abat-champ	56
Acapulco	60
Antigua	52
Balcony lampada	16
Balcony panca	12
Balcony pouf	24
Balcony tavolino	20
Balux	64
Fico d'india	44
Flute	72
Lighthouse	54
Manila	48
Margarita	38

Merlino	66
Onda	78
Panama	60
Pemba	32
Robinson	70
Salito	36
Tabasco	76
Tobago	50
Santiago	42
Wine	39
Window	40
Zanzibar	32

Colori

EN Colors



NE
NEUTRO

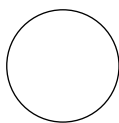

BI
BIANCO

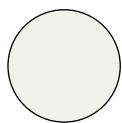

77
BIANCO PERLA

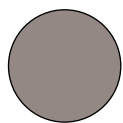

78
TORTORA

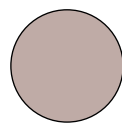

97
CIPRIA

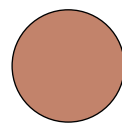

61
BRICK

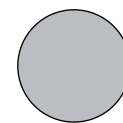

71
COOL GREY

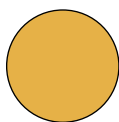

56
SENAPE

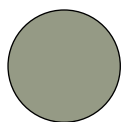

66
SALVIA



VV
VERDE

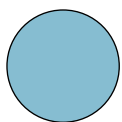

49
PALE TURQUOISE

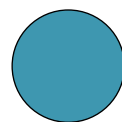

48
DARK TURQUOISE

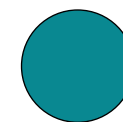

50
EMERALD

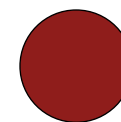

57
MARSALA



Polietilene
Polyethylene



PMMA
Plexiglass

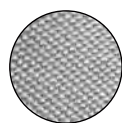

Tessuto idrorepellente
Water repellent fabric



Legno okumè
color noce
*Plywood wood
walnut color*



Legno okumè
verniciato "cool grey"
*Plywood wood
varnished "cool grey"*



Legno okumè
verniciato "bianco"
*Plywood wood
varnished "white"*



Legno okumè
verniciato "antracite"
*Plywood wood
varnished "anthracite"*



Legno multistrato
Plywood

Copyright

Art Direction: Nui Design Studio

Visual: Nui Design Studio

Rendering: Nui Design Studio

Cover image: Pexels – Photo by Mark Angelo Sampan

Pg. 4: Unsplash – Photo by De an Sun

Pg. 4: Unsplash – Photo by Robin Canfield

Pg. 5: Pexels – Cottonbro Studio

Copywriter: Alessandro Rea



Telcom Spa

Via dell'Industria, 21
72017 Ostuni (BR) ITALY
Tel. +39 0831 348 111 r.a.
Fax +39 0831 304 510

telcom@telcomitalia.it
telcom@legalmail.it

www.telcomitalia.eu

Telcom[®]
TECNOLOGIE PER L'UOMO